

NE-18 Series Mains / Power Switches

Features/Benefits

- Chassis or panel mount
- Various buttons
- Various contact configurations
- RoHS compliant

Typical Applications

- Mains/power switching
- Consumer electronics
- Audio equipment
- Digital products

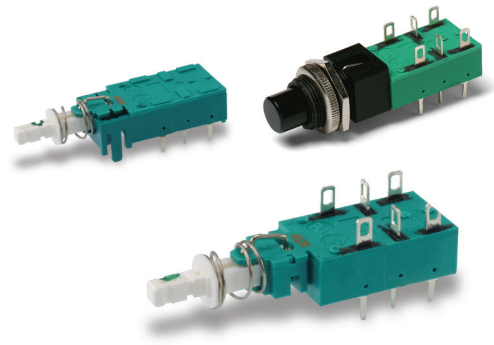

UL61058-1



Specifications

ELECTRICAL RATING:

NE18 Series:

- 8A GP, 125 VAC, 50/60 Hz, 1E4, T70
- 6A GP, 250 VAC, 50/60 Hz, 1E4, T70
- 6(4)A RM, 250 VAC, 50/60 Hz, 1E4, T70
- 6/48A RC, 250 VAC, 50/60 Hz, 1E4, T70
- 1RA, 100 VDC, 1E4, T70
- 8RA, 30VDC, 1E4, T70

NE18CTII Series:

- 4A GP, 250 VAC, 50/60 Hz, 1E4, T70
- 4/48A RC, 250 VAC, 50/60 Hz, 1E4, T70
- 1RA, 100 VDC, 1E4, T70
- 4RA, 30VDC, 1E4, T70

DIELECTRIC STRENGTH (50 Hz, 1 min.): 2000 V

OPERATING LIFE AT MAX. LOAD AND AT MAX. INRUSH CURRENT: $\wedge 10^4$ operations⁵

CONTACT RESISTANCE: Initial: 50m Ω ; After 10^4 operations: 70m Ω .

INSULATION RESISTANCE: $\wedge 10^{12}$ Ω chassis – nearest contact; $\wedge 10^{12}$ Ω mains contact – mains contact; $\wedge 10^{12}$ Ω mains contact – mains contact after 10^4 operations.

LOW VOLTAGE CONTACT:

SWITCHING POWER MAX.: 12W

SWITCHING VOLTAGE MAX.: 24V

SWITCHING CURRENT MAX.: 0.5A

TOTAL TRAVEL: 4.7mm (.185 inch)

LATCHING TRAVEL: 3.3mm (.130 inch)

OPERATING FORCE: Without auxiliary low voltage contacts:

NE18: 7N (700 grams); NE18CTII: 9.5N (950 grams).

With auxiliary low voltage contacts: NE18: 8N (800 grams).

SEALING: Dust proof.

Materials

HOUSING, ACTUATOR & TERMINAL BOARD: Thermoplastic polyester (UL 94V-0).

MOVABLE CONTACT: Silver nickel alloy, silver plated.

FIXED CONTACTS: Silver nickel alloy, silver plated.

COMMON CONTACTS & TERMINALS: Copper alloy, silver plated.

RETURN SPRING: Music wire.

NOTE: All models are RoHS compliant and compatible.

NOTE: Specifications and materials listed above are for switches with standard options. For information on specific and custom switches, consult Customer Service Center.

Build-A-Switch

To order, simply select desired option from each category and place in the appropriate box. Available options are shown and described on pages A-97 thru A-104. For additional options not shown in catalog, consult Customer Service Center.

If requesting only a switch, select the switch as noted below. Buttons are sold separately.

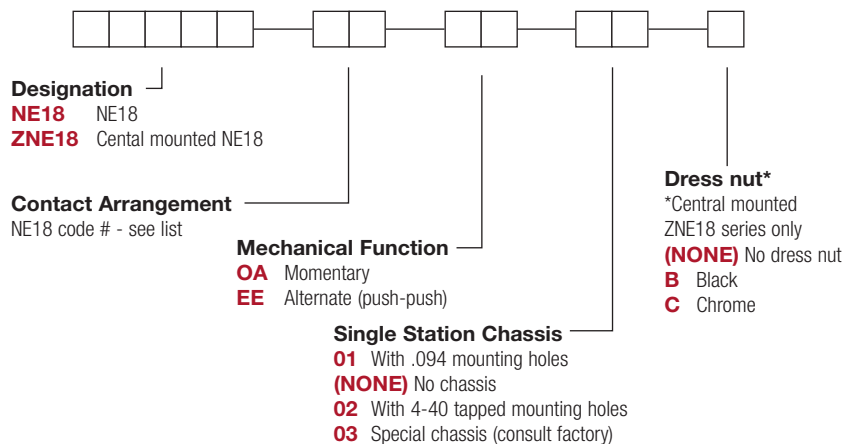



Order Code - Buttons

Solid Buttons

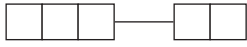

Style

- F01** FMR
- F02** FG*
- F12** FSC
- F13** FSD
- F14** FU12
- F15** FSB
- F16** FE
- F19** FA
- F21** F001

Button Color

- 01** Black
- 02** White
- 03** Red
- 04** Light gray

Mechanical Indicator Buttons

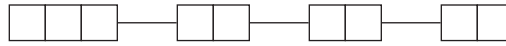

Style

- F01** FA100
- F02** FA101
- F07** FA120
- F08** FA201
- F11** FA200*

Shell Color

- 01** Black

Out Position Color

- 01** Black

In Position Color

- 02** White
- 06** Yellow
- 07** Blue
- 08** Green
- 12** Orange

*Button options for central mounting configurations, use 'FG' for central mount with chrome dress nut, use 'FA200' for central mount with black dress nut.

BUTTON REMOVAL

A button of a push-push switch should only be removed in the "OFF" non-latching position.

DESIGNATION & SWITCHES WITH STANDARD OPTIONS



NE1838EE

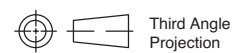
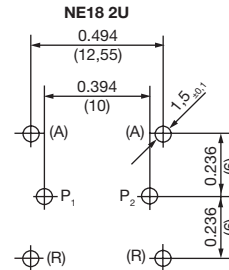
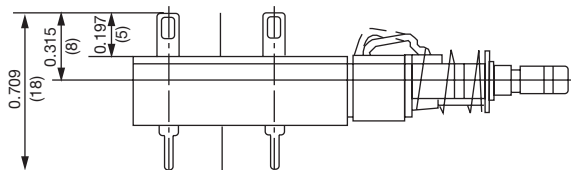
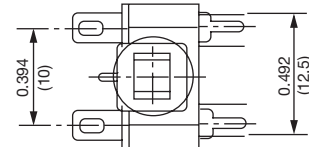
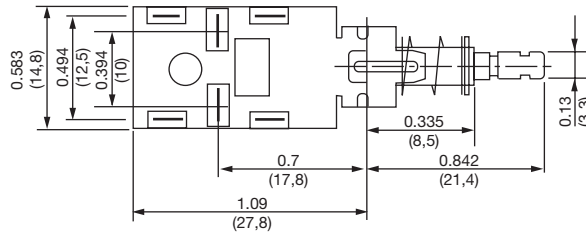
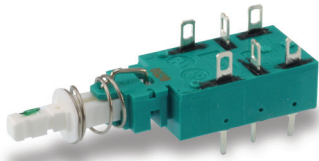

Dimensions are shown: Inches (mm)
Specifications and dimensions subject to change



NE-18 Series Mains / Power Switches

DESIGNATION & SWITCHES WITH STANDARD OPTIONS



Pushbutton

NE1839EE

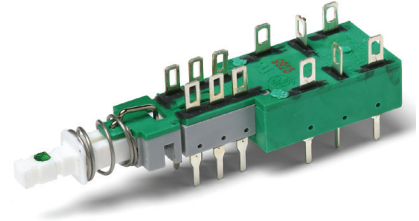
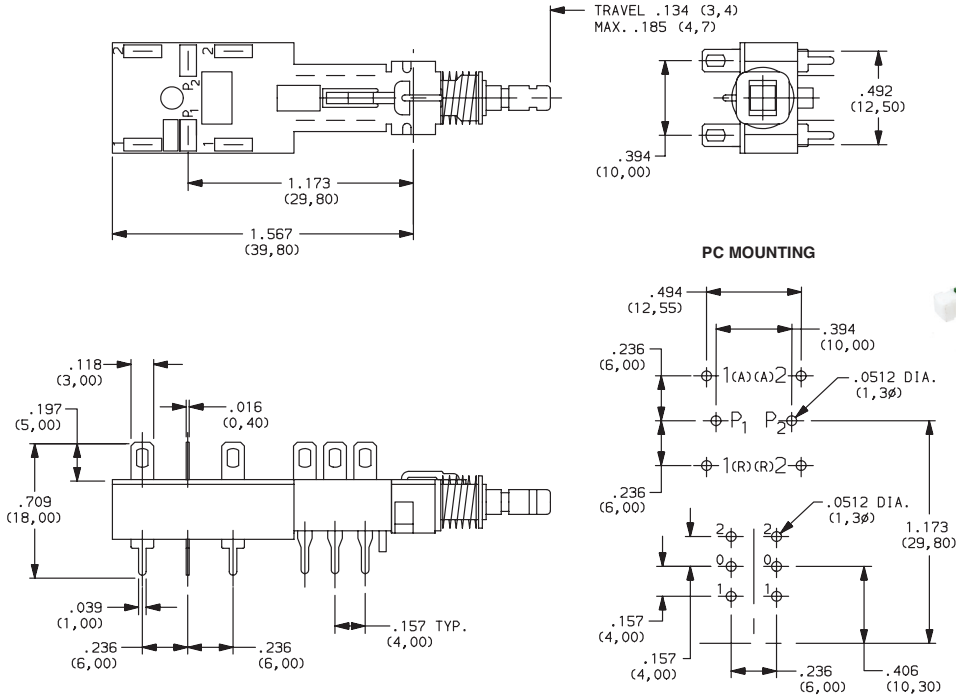

NE1846EE

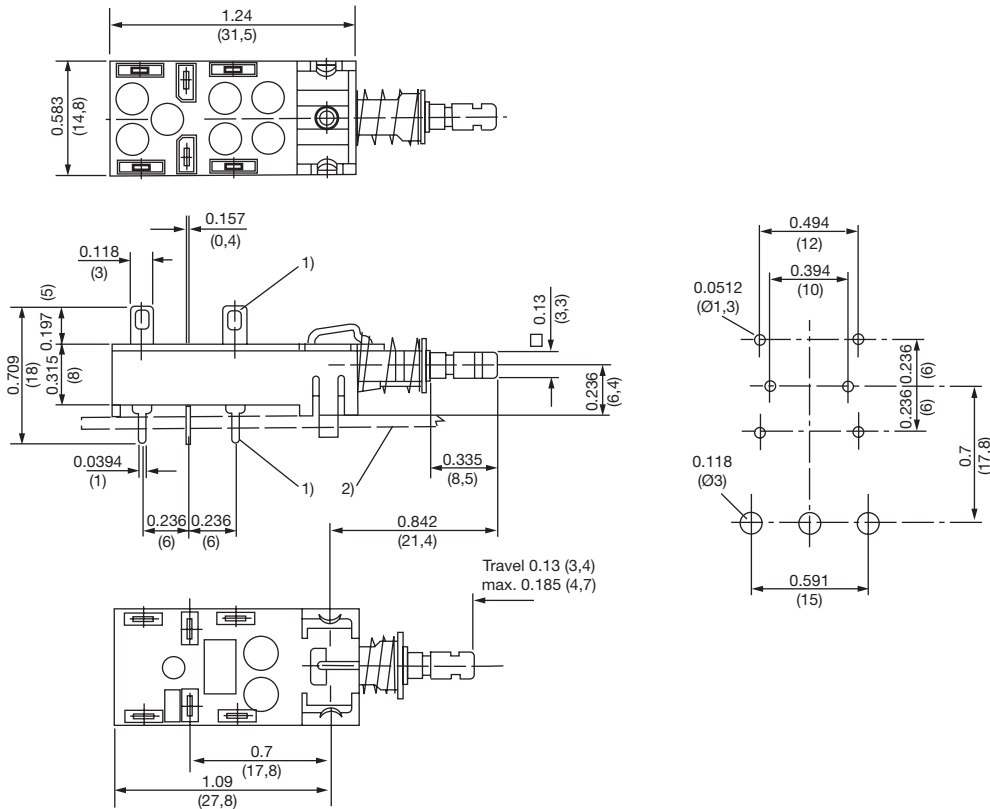

Dimensions are shown: Inches (mm)
Specifications and dimensions subject to change



22 Dec 21



DESIGNATION & SWITCHES WITH STANDARD OPTIONS



ZNE1838EECF0201

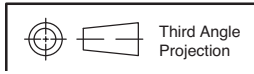
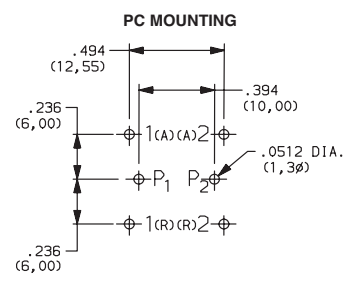
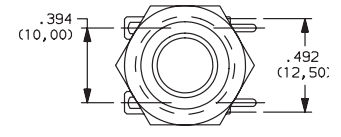
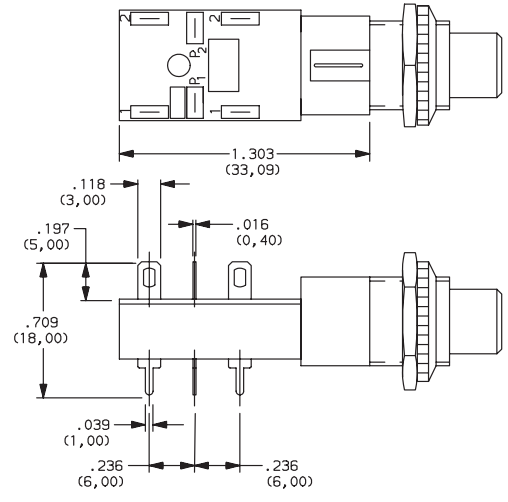
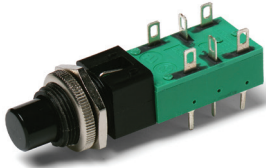



NE-18 Series Mains / Power Switches

CONTACT ARRANGEMENT





Pushbutton
A

| OPTION CODE Contact capacity and availability | STYLE | ELECTRICAL CIRCUIT |
|---|-----------------|-----------------------|
| 37 | NE18 – 2AX | DPST |
| 38 | NE18 – 2UX | DPDT |
| 51 | 2U + NE18 – 2AX | DPST* |
| 52 (4A/64) | NE18CTII – 2AX | DPST |
| 39 | 2U + NE18 – 2UX | DPDT* |
| 41 | NE18 – 2AP | DPST |
| 42 | NE18 – 2UP | DPDT |
| 43 | NE18 – 2AW | DPST |
| 44 | NE18 – 2UW | DPDT |
| 45 | NE18 – 2ASX | DPST |

| OPTION CODE Contact capacity and availability | STYLE | ELECTRICAL CIRCUIT |
|---|-----------------|-----------------------|
| 46 | NE18 – 2USX | DPDT |
| 47 | NE18 – 2ASP | DPST |
| 48 | NE18 – 2USP | DPDT |
| 49 | NE18 – 2ASW | DPST |
| 50 | NE18 – 2USW | DPDT |
| 54 | 2U + NE18 – 2AW | DPST |
| 55 | 2U + NE18 – 2AP | DPST |
| 56 | 2U + NE18 – 2UW | DPDT |
| 57 | 2U + NE18 – 2UP | DPDT |

* 2U + Denotes auxiliary set of low current contacts DPDT
 2A = DPST
 2U = DPDT
 S = Snap-in mounting
 X = Solder lug/PC pins
 W = Solder lugs only
 P = PC pins only

NOTES
 1. Contact plating is silver on all Power Switches.
 2. The electrical function is Break Before Make (BBM) on all Power Switches.
 3. The terminals will be epoxy sealed.

| TYPE | POSSIBLE CONTACT ARRANGEMENT | | CONTACT SPACING | PROTECTION CLASS (CEE 24) | APPROVALS |
|----------|------------------------------|--------------------|----------------------|------------------------------|--|
| | POWER CONTACTS ¹ | AUXILIARY CONTACTS | | | |
| NE18 | 2A ² | 2U | > 3mm (.118 inch) | II |  UL61058-1 |
| NE18 | 2A ² 2U | 2U | > 3mm (.118 inch) | I |  UL61058-1 |
| NE18CTII | 2A ² | | > 3mm (.118 inch) | II |  UL61058-1 |

1) A = make contact, U = changeover contact
 2) With 2A mains contacts: Mounting only by PC pins is not sufficient.

MECHANICAL FUNCTION



| OPTION CODE | FUNCTION |
|-------------|-----------------------|
| OA | Momentary |
| EE | Alternate (push-push) |

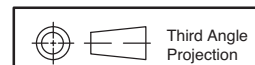

Dimensions are shown: Inches (mm)
 Specifications and dimensions subject to change



22 Dec 21



SINGLE STATION CHASSIS



01 WITH .094 MOUNTING HOLES

(NONE) NO CHASSIS

02 WITH 4-40 TAPPED MOUNTING HOLES

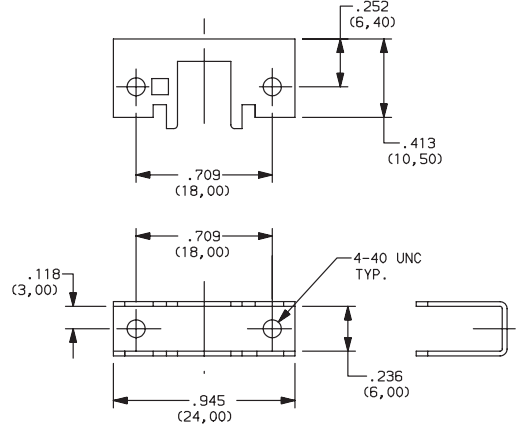
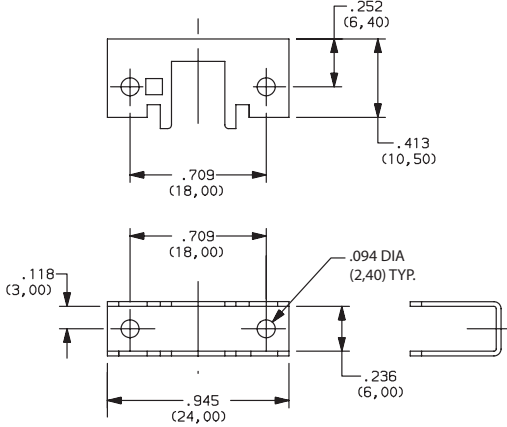

03 SPECIAL CHASSIS (CONSULT FACTORY)

DRESS NUT



(NONE) NO DRESS NUT

B BLACK

C CHROME



PANEL CUTOUT

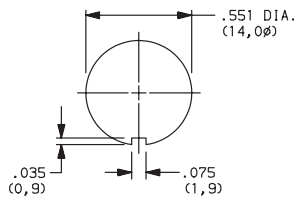

NOTE: Available with ZNE18 designation and FA200 buttons.

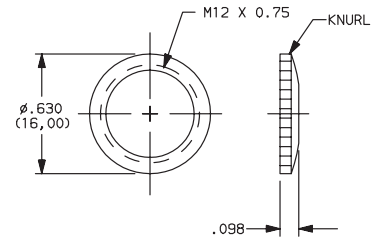

PANEL CUTOUT

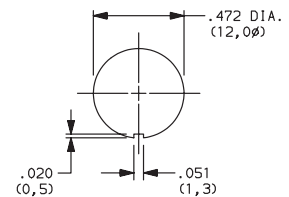

NOTE: Available with ZNE18 designation and FG button.



NE-18 Series Mains / Power Switches

SOLID BUTTON

Pushbutton A

STYLE

F01 FMR

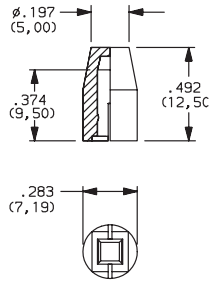

F02 FG

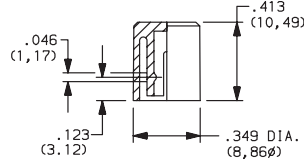

F12 FSC

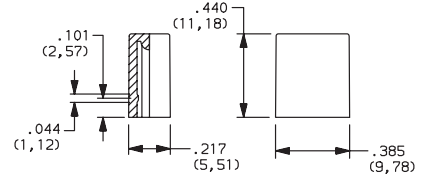
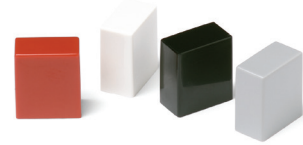

F13 FSD

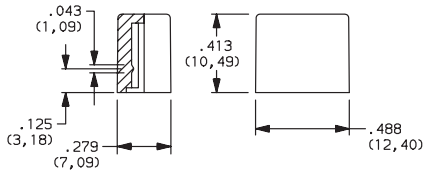
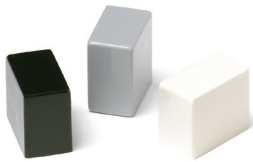

F14 FU12

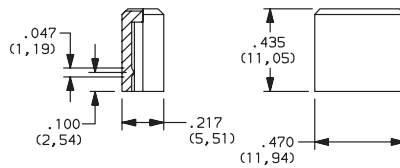
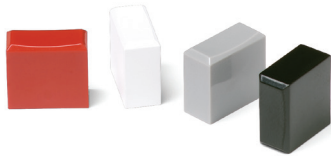

F15 FSB

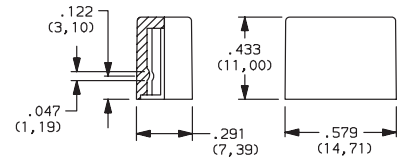
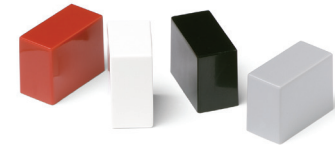

F16 FE

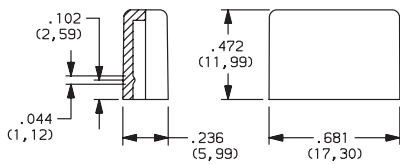
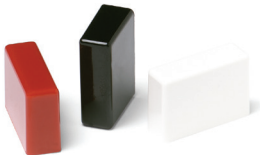

F19 FA

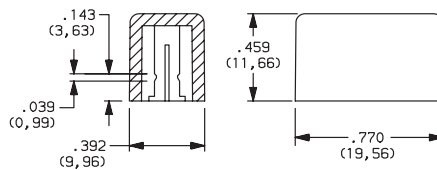

| OPTION CODE | COLOR |
|-------------|----------|
| 01 | BLACK |
| 02 | WHITE |
| 03 | RED |
| 04 | LT. GRAY |



Dimensions are shown: Inches (mm)
Specifications and dimensions subject to change



SOLID BUTTON

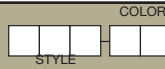

STYLE

F21 F001

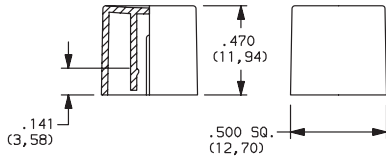

| OPTION CODE | COLOR |
|-------------|---|
| 01 | BLACK |
| 02 | WHITE |
| 03 | RED |
| 04 | LT. GRAY |
| 09 | BLACK/CHROME (F03, F06 & F07 buttons only) |

MECHANICAL BUTTON



STYLE

F01 FA100

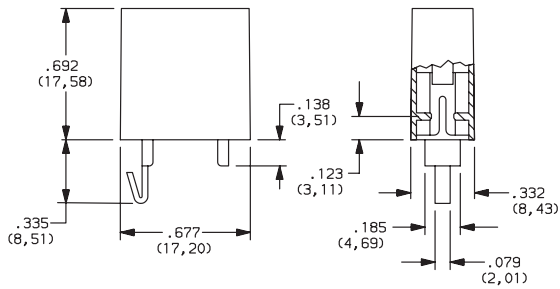

F02 FA101

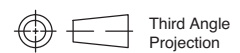
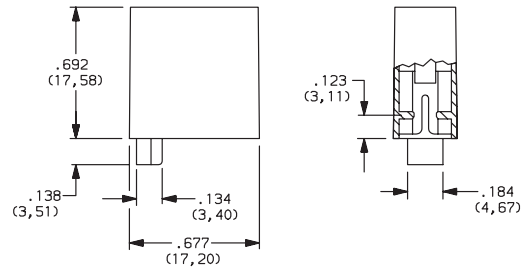

Dimensions are shown: Inches (mm)
Specifications and dimensions subject to change



NE-18 Series Mains / Power Switches

MECHANICAL BUTTON



Pushbutton A

STYLE

F08 FA201

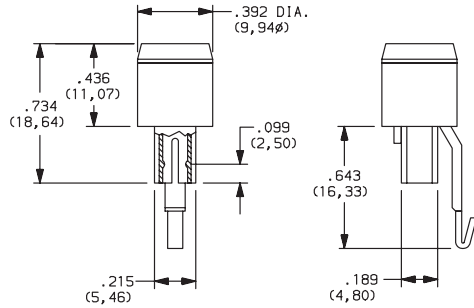

F11 FA200



SHELL COLOR

01 BLACK

OUT POSITION COLOR

01 BLACK

IN POSITION COLOR

| OPTION CODE | COLOR |
|-------------|--------|
| 02 | WHITE |
| 06 | YELLOW |
| 07 | BLUE |
| 08 | GREEN |
| 12 | ORANGE |



22 Dec 21

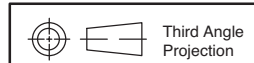

Dimensions are shown: Inches (mm)
Specifications and dimensions subject to change

Mouser Electronics

Authorized Distributor

Click to View Pricing, Inventory, Delivery & Lifecycle Information:

C&K Switches:

[NE182UEE6AMP](#) [NE18CTII2AEE4AMP](#) [NE182AEESNL6AMP](#) [NE182A2UEE6AMP](#) [NE182UEEP6AMP](#)
[NE182AEESN6AMP](#) [NE182UEEL6AMP](#) [NE182AEESNP6AMP](#) [NE182AEEP6AMP](#) [NE182AEEL6AMP](#)
[NE182AEE6AMP](#) [NE182UEESNP6AMP](#) [NE182UEESN6AMP](#) [NE182U2UEE6AMP](#) [1XNE182UEEP](#) [1XNE182A2UEE](#)
[1XNE18CTII2AEE](#) [1XNE18FSDGY2A2UEEL](#) [1XNE182AEEL](#) [1XNE182AEEP](#) [1XNE182U2UEE](#) [1XNE182UEE](#)
[1XNE182AEE](#) [1XNE18CTII 2A EE 3111000308](#) [1XNE182UEEL](#) [NE18CTII2AEESNP4AMP](#) [NE18CTII2AEESN4AMP](#)
[ZNE18FA200BK0G2UEE](#) [ZNE18 FA200 BK OG 2U EE L](#)